

Series
VENTS KAM



Chimney centrifugal fan for house heating system management using heat of chimney or fireplace. It can be also used as a base for backup heating source.

■ **Applications**

Chimney fans for hot air distribution allow creating fully-featured air heating system based on a fireplace. Such system is the perfect solution for heating of seasonal houses that serve as a second residence during winter time and provides fast and efficient hot air distribution from chimney to other premises. Used for air distribution with the air temperature range 0 °C to +150 °C.

■ **Design**

The fan casing is made of galvanized steel and equipped with heat- and sound insulation of fire-resistant mineral wool. The casing is perforated for the internal air circulation and motor cooling. The temperature regulator is used for setting the temperature level for the fan switching on and off. Fan startup is effected within the range of 0 °C to +90 °C depending on the air temperature generated inside the fireplace heat-exchanger.

■ **Motor**

The fans are supplied with single phase motors for operation in 230/50 Hz power supply network. Insulation Class F. The motors have built-in overheating protection with automatic restart. The motor is placed off-airflow and is equipped with forward curved impeller blades as well as ball bearings for long service life. The fan models marked KAM are equipped with asynchronous motors and extra impeller for air blowing-off and cooling. The fan motors models marked KAM Eco are equipped with the external rotor. KAM Eco max fans are equipped with the high powered external rotor motor. The fan motors models marked KAM EcoDuo have two speeds and equipped with the external rotor.

■ **Speed control**

Both smooth and step fan control is performed by means of the thyristor or autotransformer (Models KAM, KAM Eco). The fan speed is controlled within the range of 0 to 100%. KAM EcoDuo fan speed is controlled by means of the speed switch.

■ **Mounting**

The fireplace fans are designed for connection with round air ducts. The fans can be mounted in any position with respect to the airflow direction indicated with a pointer on the casing. Access for the fan maintenance shall be reserved. Warm air feed ducts shall be laid between the fan and each of the heated rooms. Concealed air ducts system with forced warm air circulation allows saving useful space in the house and fits to the house design.

■ **Accessories**

FFK – removable G3 metal filter-box for boosted air purification. The filter is connected to the fan casing by lock-latches to provide easy removal of the filter for cleaning.

KFK – removable metal mixing chamber with incorporated heat control damper and G3 filter for boosted air purification. The mixing set is fixed to the fan casing by means of lock-latches to ensure easy removal for cleaning. Fan configuration with KFK mixing chamber provides cool air supply into the mixing chamber when the operating temperature exceeds +90 °C. Such configuration also allows hot air withdrawal while the fan motor is not running.

GFK – gravitation backdraft damper to prevent air back draft in the system. Such fan configuration that includes KFK mixing set and GFK backdraft damper ensures fan motor overheating protection based on BY-PASS actuation, in particular when the motor is not running due to no power supply. This design enables backdraft damper shutting and hot air distribution to other premises through ventilation ducts when the motor is not running.

Designation key:

Series	Air duct diameter	Motor	Modifications
VENTS KAM	125; 140; 150; 160; 200	Eco – external rotor; Eco max – high powered external rotor motor; EcoDuo – two-speed with external rotor.	– – temperature regulator by default; T1 – no temperature regulator.

Accessories



page 417 page 417

Accessories



MFK FFK KFK GFK TS-1-90

1

KAM fans operating logic



When air temperature in the fireplace hood reaches the set point, the fan turns automatically on (fig. 1b) and distributes hot air from the fire hood place to other premises. It turns off, when the temperature falls down below the set point (fig. 1a).

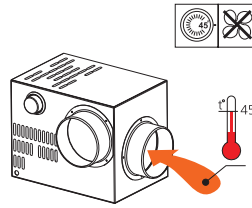

fig.1a

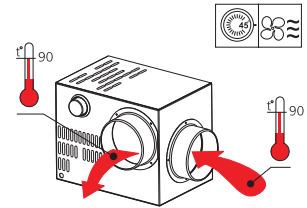

fig.1b

2

Operating logic of KAM fan with FFK filter box



KAM

FFK

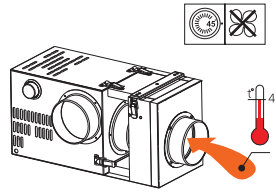

fig.2a

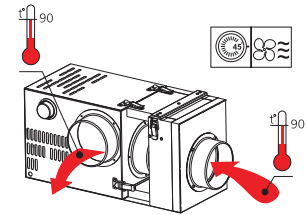
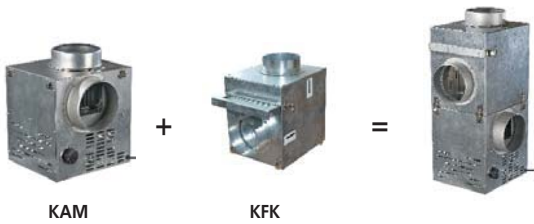

fig.2b

When air temperature in the fireplace hood reaches the set point, the fan turns automatically on (fig. 2b) and distributes purified through the FFK filter hot air from the fire hood place to other premises. It turns off, when the temperature falls down below the set point (fig. 2a).

3

Operating logic of KAM filter with KFK mixing chamber and integrated heat control damper



KAM

KFK

When air temperature in the fireplace hood reaches the set point, the fan turns automatically on (fig. 3b) and distributes purified hot air from the fire hood place to other premises. It turns off, when air temperature falls down below the set point (fig. 3a). The fan equipped with a mixing chamber provides cold air supply to the mixing chamber (fig. 3c) if the transported air temperature exceeds +90°C and hot air removal when the fan is off (fig. 3d).

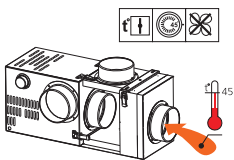

fig.3a

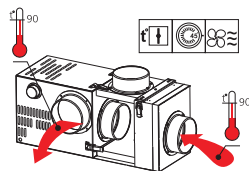

fig.3b

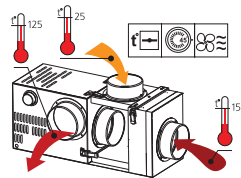

fig.3c

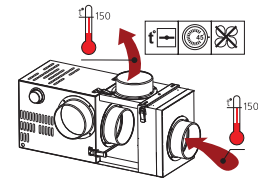
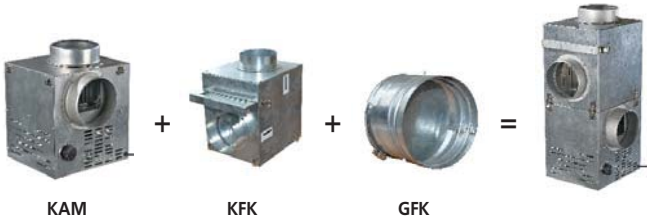

fig.3d

4

Operating logic of KAM filter with KFK mixing chamber and GFK gravity damper



KAM

KFK

GFK

When air temperature in the fireplace hood reaches the set point, the fan turns automatically on (fig. 4b) and distributes purified hot air from the fire hood place to other premises. It turns off, when the temperature falls down below the set point (fig. 4a). The **by-pass** system is designed to prevent the fan overheating, i.e. during power failure. In this case GFK damper is closed and hot air is moved through the bypas air duct besides the fan (fig. 4d). If the air supplied to the fan is too hot, the mixing chamber damper is opened to let cold air supply to the fan (fig. 4c).

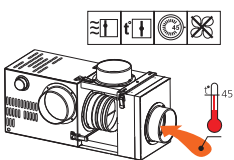

fig.4a

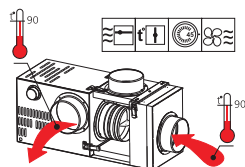

fig.4b

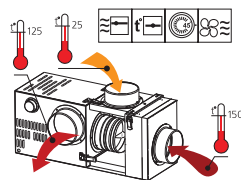

fig.4c

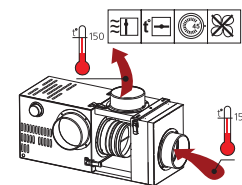
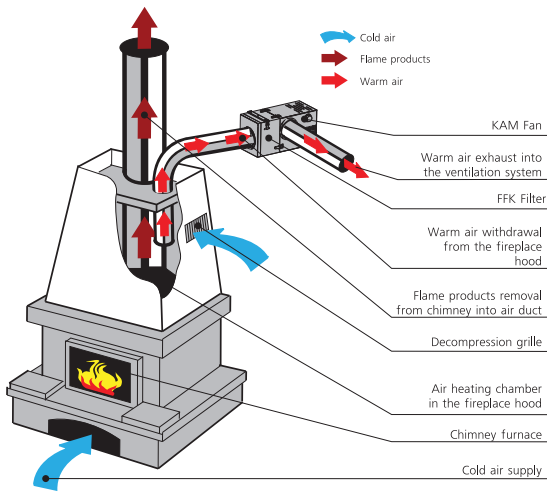

fig.4d

VENTS KAM
FAN SERIES

CHIMNEY CENTRIFUGAL FANS

Installation and operation of KAM fans with FFK filter in the chimney system



Installation and operation of KAM fans with KFK damper, KAM fans with KFK and GFK dampers with BY-PASS system in the chimney system

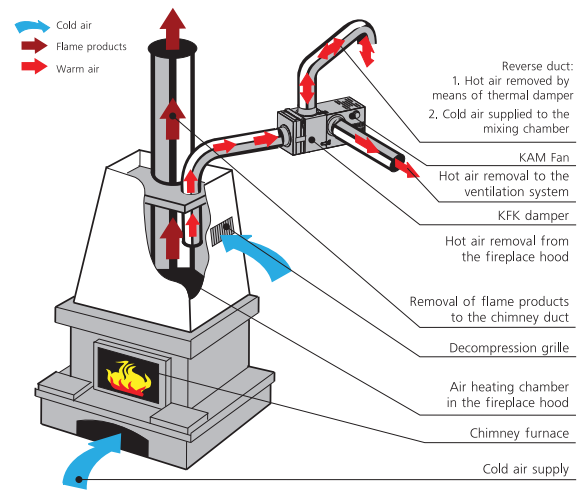

Fan overall dimensions:

Type	Dimensions [mm]						Weight [kg]
	ØD	B	H	H1	L	P	
KAM 125	124	245	350	300	260	50	5.82
KAM 140	139	285	350	300	300	50	5.82
KAM 150	149	285	350	300	300	50	6.9
KAM 160	159	285	350	300	300	50	6.9
KAM 125 Eco / EcoDuo	124	245	320	270	260	50	5.82
KAM 140 Eco / EcoDuo	139	285	320	270	300	50	5.82
KAM 150 Eco / EcoDuo / Eco max	149	285	320	270	300	50	6.9
KAM 160 Eco / EcoDuo	159	285	320	270	300	50	6.9
KAM 200 Eco	199	350	350	300	335	50	7.8

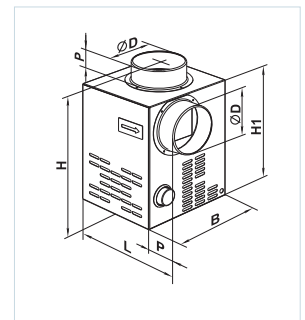

Overall dimensions of fans with additional equipment:

Type	Additional equipment	Dimensions [mm]						Weight [kg]
		ØD	B	H	H1	L	P	
KAM 125	FFK	124	245	530	480	260	50	6.7
KAM 140	FFK	139	285	540	490	300	50	8.7
KAM 150	FFK	149	285	540	490	300	50	8.7
KAM 160	FFK	159	285	540	490	300	50	8.7
KAM 125 Eco / EcoDuo	FFK	124	245	500	450	260	50	7.8
KAM 140 Eco / EcoDuo	FFK	139	285	510	460	300	50	9.8
KAM 150 Eco / EcoDuo / Eco max	FFK	149	285	510	460	300	50	9.8
KAM 160 Eco / EcoDuo	FFK	159	285	510	460	300	50	9.8

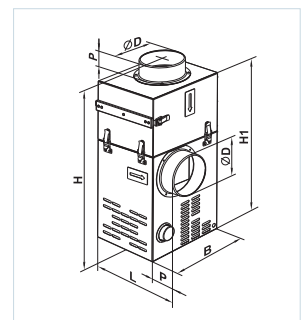

Type	Additional equipment	Dimensions [mm]						Weight [kg]
		ØD	B	H	H1	L	P	
KAM 125	KFK / KFK+GFK	124	245	610	560	260	50	8.5
KAM 140	KFK / KFK+GFK	139	285	650	600	300	50	9.7
KAM 150	KFK / KFK+GFK	149	285	650	600	300	50	9.7
KAM 160	KFK / KFK+GFK	159	285	650	600	300	50	9.7
KAM 125 Eco / EcoDuo	KFK / KFK+GFK	124	245	580	530	260	50	9.4
KAM 140 Eco / EcoDuo	KFK / KFK+GFK	139	285	620	570	300	50	10.8
KAM 150 Eco / EcoDuo / Eco max	KFK / KFK+GFK	149	285	620	570	300	50	10.8
KAM 160 Eco / EcoDuo	KFK / KFK+GFK	159	285	620	570	300	50	10.8

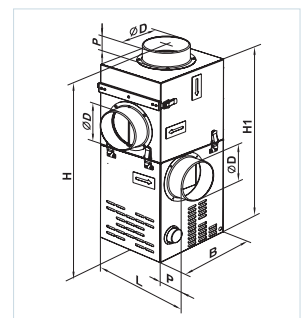

Technical data:

	KAM 125	KAM 140	KAM 150	KAM 160
Voltage [V / 50 Hz]	1~ 230	1~ 230	1~ 230	1~ 230
Power [W]	108	110	115	116
Current [A]	0.81	0.82	0.84	0.86
Max. air capacity [m³/h]	400	480	520	540
RPM [min ⁻¹]	1300	1290	1280	1270
Noise level at 3 m [dBA]	42	42	42	42
Max. transported air temperature [°C]	150	150	150	150
Protection rating	IP X2	IP X2	IP X2	IP X2

Technical data:

	KAM 125 Eco	KAM 140 Eco	KAM 150 Eco	KAM 150 Eco max	KAM 160 Eco	KAM 200 Eco
Voltage [V / 50 Hz]	1~ 230	1~ 230	1~ 230	1~ 230	1~ 230	1~ 230
Power [W]	32	41	43	127	44	179
Current [A]	0.14	0.18	0.19	0.55	0.19	0,99
Max. air capacity [m³/h]	350	420	450	740	470	810
RPM [min ⁻¹]	1335	1250	1165	1310	1110	1215
Noise level at 3 m [dBA]	37	38	39	45	39	47
Max. transported air temperature [°C]	150	150	150	150	150	150
Protection rating	IP X2	IP X2	IP X2	IP X2	IP X2	IP X2

Technical data:

	KAM 125 EcoDuo		KAM 140 EcoDuo		KAM 150 EcoDuo		KAM 160 EcoDuo	
	min.	max.	min.	max.	min.	max.	min.	max.
Speed	1~ 230		1~ 230		1~ 230		1~ 230	
Voltage [V / 50 Hz]	1~ 230		1~ 230		1~ 230		1~ 230	
Power [W]	26	32	32	41	34	43	35	44
Current [A]	0.12	0.14	0.14	0.18	0.15	0.19	0.15	0.19
Max. air capacity [m³/h]	265	350	340	420	360	450	375	470
RPM [min ⁻¹]	1210	1335	1180	1250	1075	1165	1040	1110
Noise level at 3 m [dBA]	29	37	31	38	31	39	32	39
Max. transported air temperature [°C]	150		150		150		150	
Protection rating	IP X2		IP X2		IP X2		IP X2	

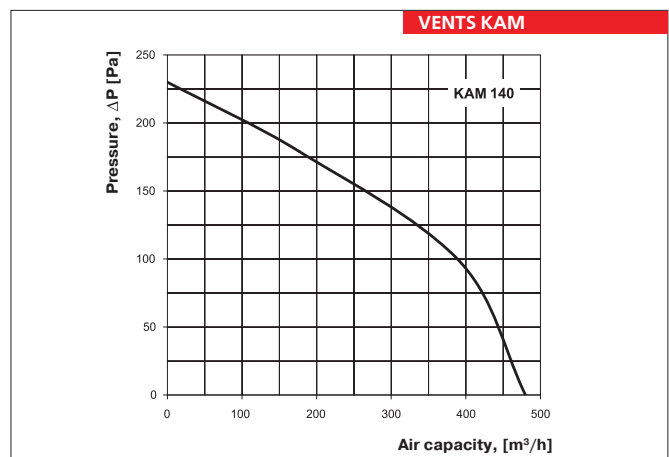
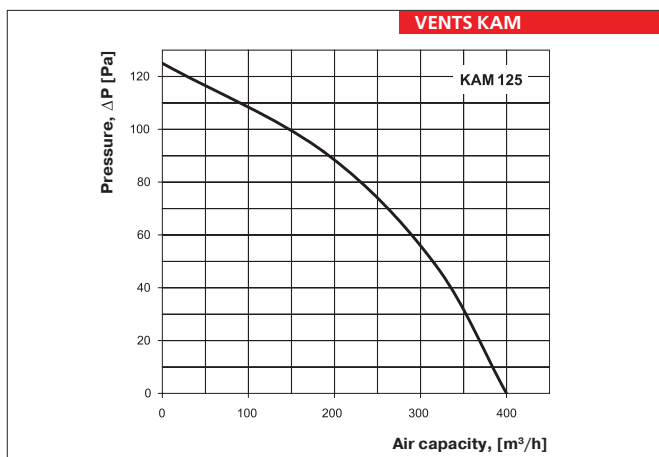

CHIMNEY CENTRIFUGAL FANS

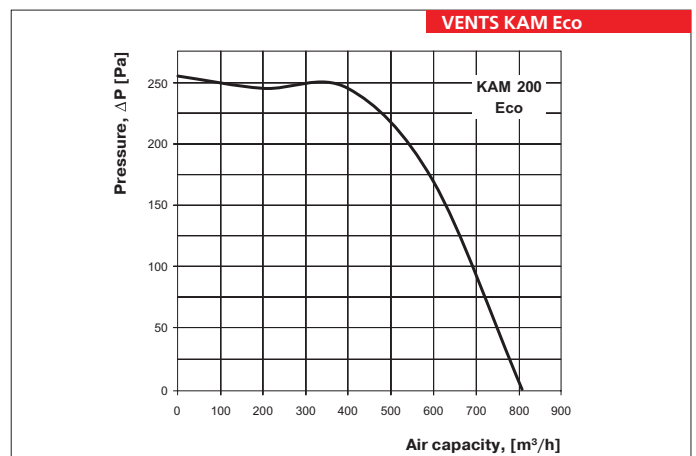
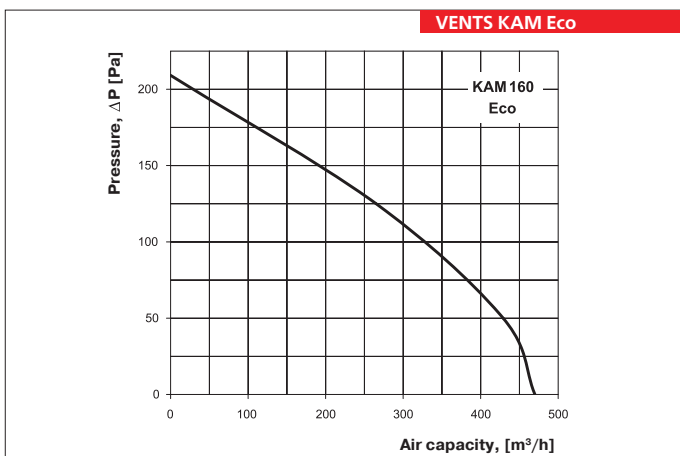
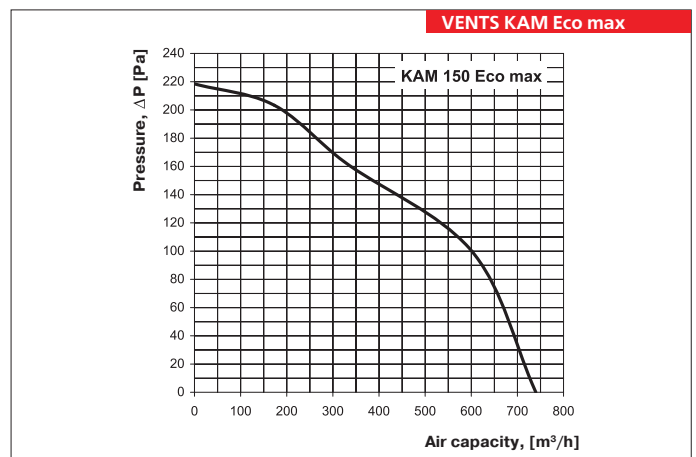
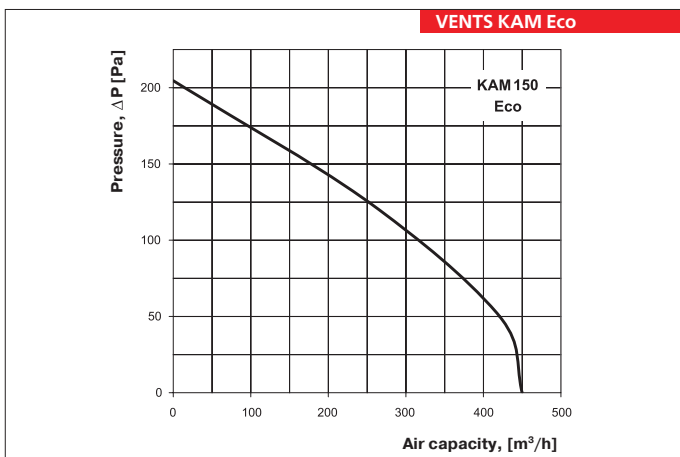
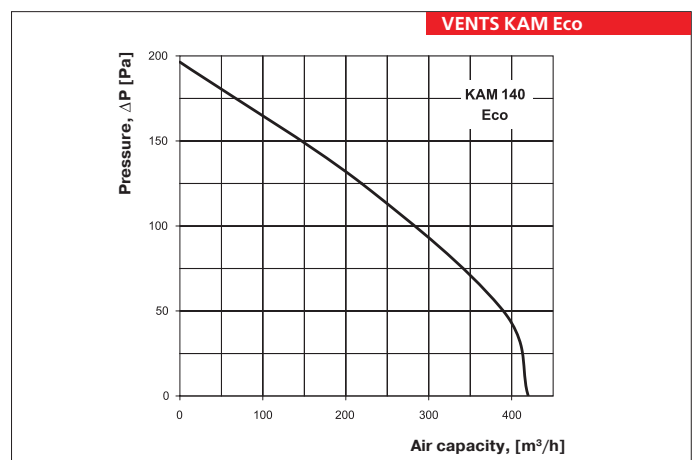
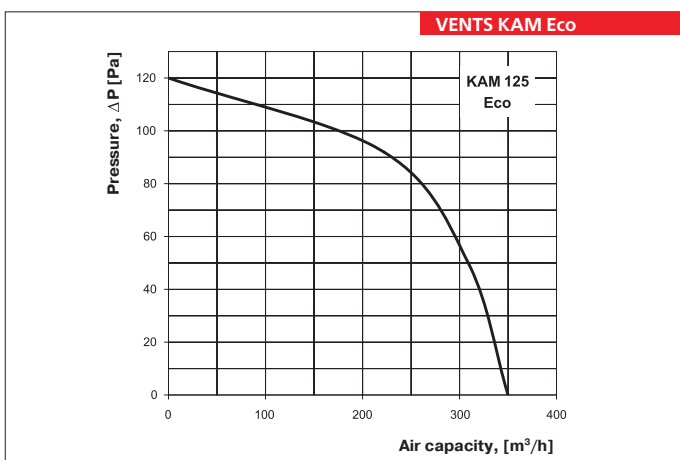
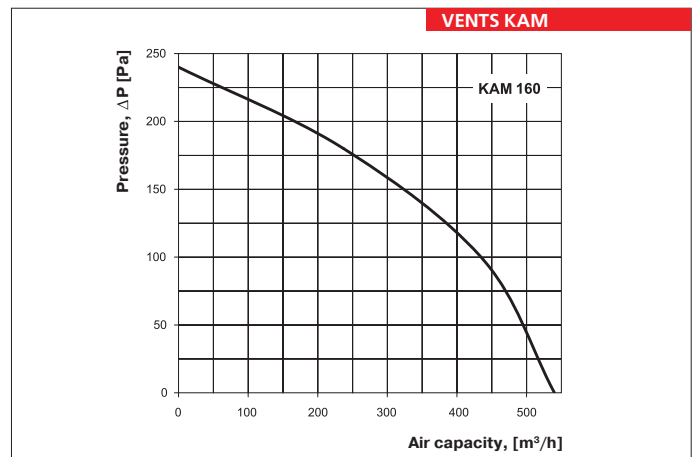
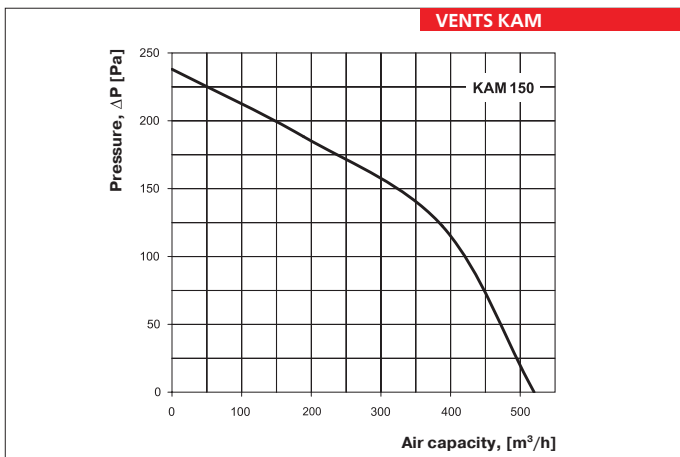

ELECTRICAL ACCESSORIES COMPATIBILITY

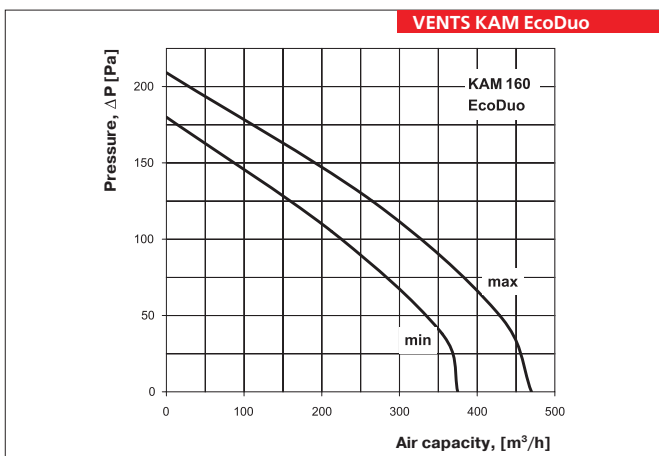
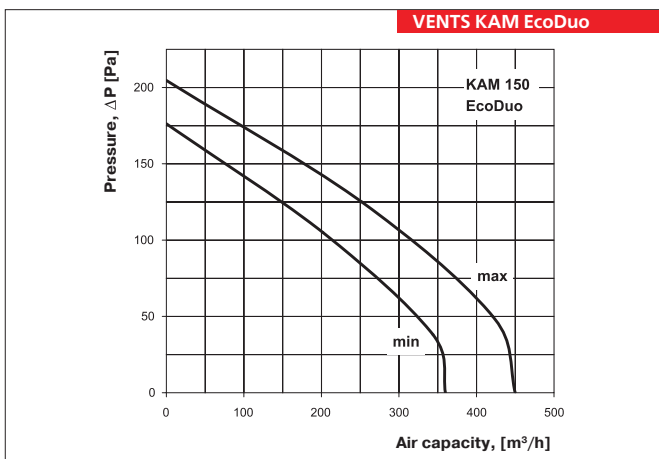
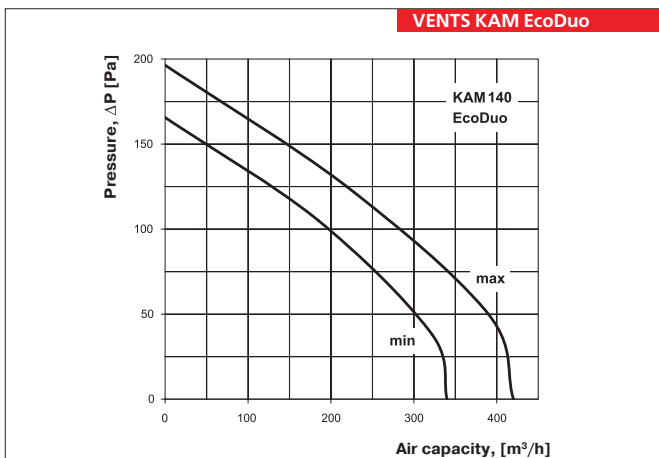
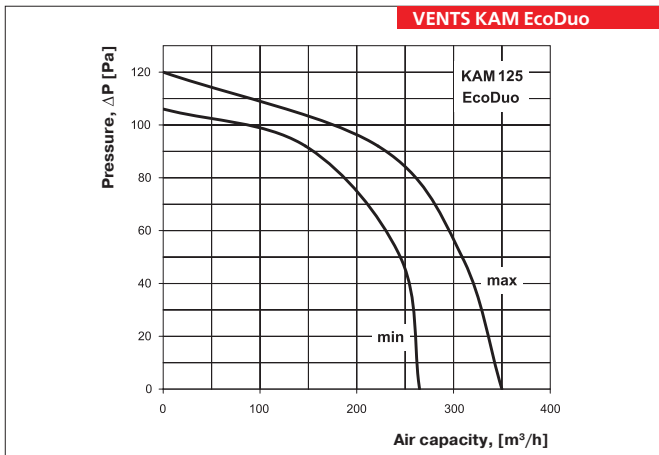

		KAM 125	KAM 140	KAM 150	KAM 160	KAM 125 Eco	KAM 140 Eco	KAM 150 Eco	KAM 150 Eco max	KAM 160 Eco	KAM 200 Eco	KAM 125 EcoDuo	KAM 140 EcoDuo	KAM 150 EcoDuo	KAM 160 EcoDuo
Thyristor speed controllers															
	RS-1-300	•	•	•	•	•	•	•	•	•	•				
	RS-1-400	•	•	•	•	•	•	•	•	•	•				
	SRS-1	•	•	•	•	•	•	•	•	•	•				
	RS-1 N (V)	•	•	•	•	•	•	•	•	•	•				
	RS-1,5 N (V)	•	•	•	•	•	•	•	•	•	•				
	RS-2 N (V)	•	•	•	•	•	•	•	•	•	•				
	RS-2,5 N (V)	•	•	•	•	•	•	•	•	•	•				
	RS-0,5-PS	•	•	•	•	•	•	•	•	•	•				
	RS-1,5-PS	•	•	•	•	•	•	•	•	•	•				
	RS-2,5-PS	•	•	•	•	•	•	•	•	•	•				
	RS-4,0-PS	•	•	•	•	•	•	•	•	•	•				
	RS-3,0-T	•	•	•	•	•	•	•	•	•	•				
	RS-5,0-T	•	•	•	•	•	•	•	•	•	•				
	RS-10,0-T	•	•	•	•	•	•	•	•	•	•				
	RS-3,0-TA	•	•	•	•	•	•	•	•	•	•				
	RS-5,0-TA	•	•	•	•	•	•	•	•	•	•				
	RS-10,0-TA	•	•	•	•	•	•	•	•	•	•				
Transformer speed controllers															
	RSA5E-2-P	•	•	•	•	•	•	•	•	•	•				
	RSA5E-2-M	•	•	•	•	•	•	•	•	•	•				
	RSA5E-3-M	•	•	•	•	•	•	•	•	•	•				
	RSA5E-4-M	•	•	•	•	•	•	•	•	•	•				
	RSA5E-12-M	•	•	•	•	•	•	•	•	•	•				
	RSA5E-1,5-T	•	•	•	•	•	•	•	•	•	•				
	RSA5E-3,5-T	•	•	•	•	•	•	•	•	•	•				
	RSA5E-5,0-T	•	•	•	•	•	•	•	•	•	•				
	RSA5E-8,0-T	•	•	•	•	•	•	•	•	•	•				
	RSA5E-10,0-T	•	•	•	•	•	•	•	•	•	•				
	RSA5D-1,5-T	•	•	•	•	•	•	•	•	•	•				
	RSA5D-3,5-T	•	•	•	•	•	•	•	•	•	•				
	RSA5D-5-M														
	RSA5D-8-M														
	RSA5D-10-M														
	RSA5D-12-M														
Frequency speed controllers															
	VFED-200-TA														
	VFED-400-TA														
	VFED-750-TA														
	VFED-1100-TA														
	VFED-1500-TA														
Temperature regulators															
	RTS-1-400											•	•	•	•
	RTSD-1-400											•	•	•	•
	TST-1-300											•	•	•	•
	TSTD-1-300											•	•	•	•
	RT-10	•	•	•	•	•	•	•	•	•	•	•	•	•	•
Multi-speed fan switches															
	P2-5,0											•	•	•	•
	P3-5,0											•	•	•	•
	P5-5,0											•	•	•	•
	P2-1-300											•	•	•	•
	P3-1-300											•	•	•	•
	SP3-1														
EC motors controllers															
	R-1/010														
Sensors															
	T-1,5 N	•	•	•	•	•	•	•	•	•	•	•	•	•	•
	TH-1,5 N	•	•	•	•	•	•	•	•	•	•	•	•	•	•
	TF-1,5 N	•	•	•	•	•	•	•	•	•	•	•	•	•	•
	TP-1,5 N	•	•	•	•	•	•	•	•	•	•	•	•	•	•

• recommended
• suitable

FAN SERIES
VENTS KAM